

アンカー一覽

水平荷重 水平荷重試験を実施し、基準値を満たしていることを示します

ツイン 50	
H=1200以下	
水平荷重	3480N
	1,450N/m
躯体巾	180mm

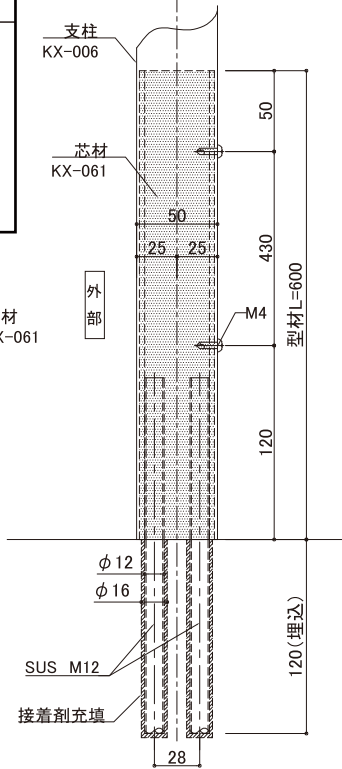
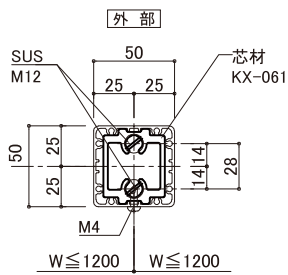
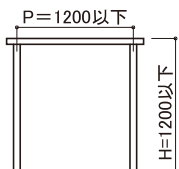

ツイン 50	
H=400以下	
水平荷重	3480N
	1,450N/m
躯体巾	120mm

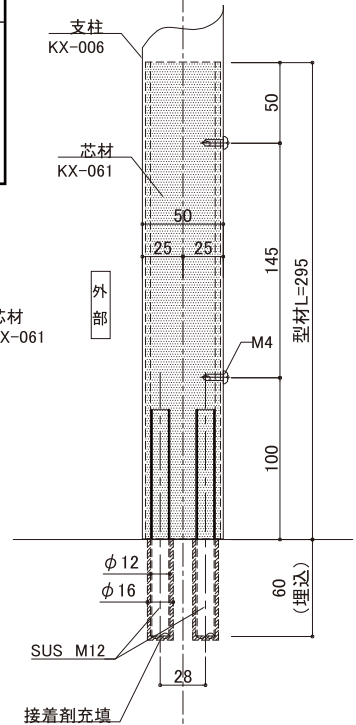
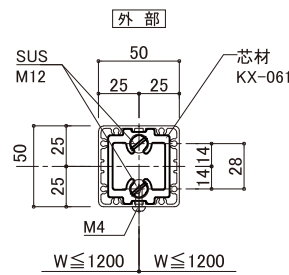
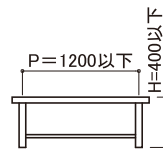

スパイラル 50	
H=1200以下	
水平荷重	3480N
	1,450N/m
躯体巾	180mm

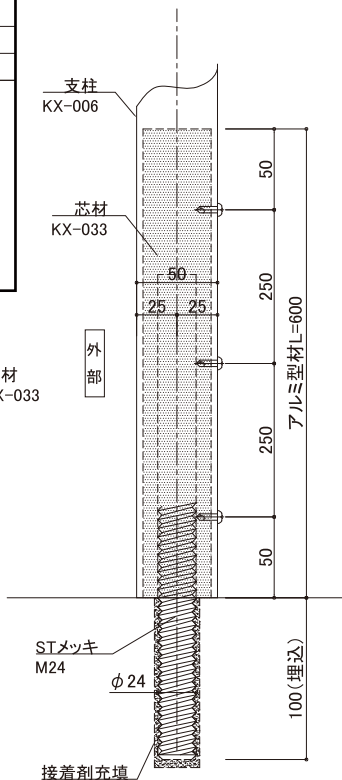
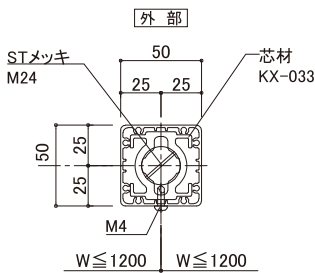
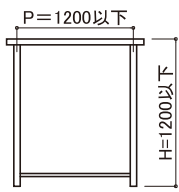

打込みアンカー 50	
トップレール H=300以下	
水平荷重	980N/本
躯体巾	120mm

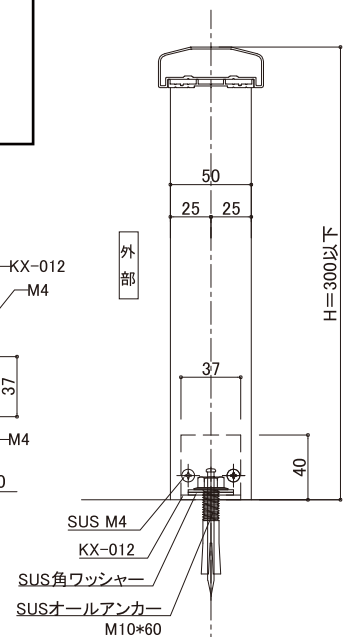
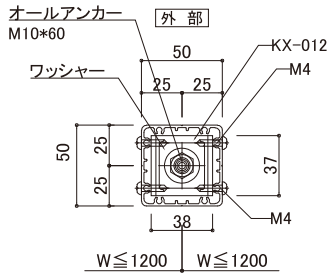
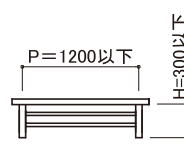

スリムツイン 35	
H=1200以下	
水平荷重	3480N
	1,450N/m
躯体巾	180mm

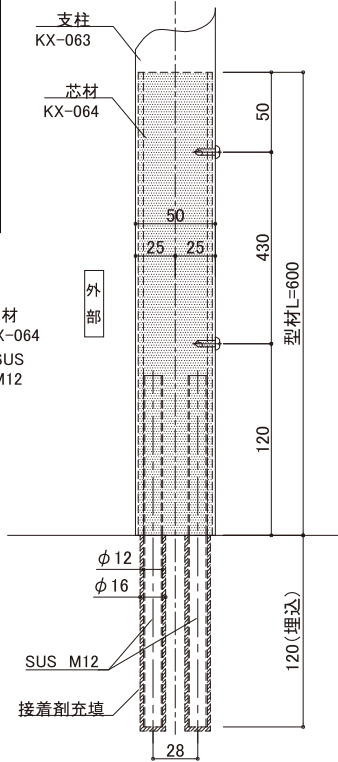
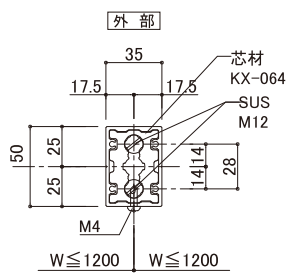
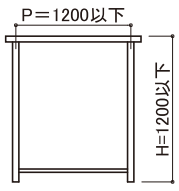

スリムツイン 35	
H=400以下	
水平荷重	3480N
	1,450N/m
躯体巾	120mm

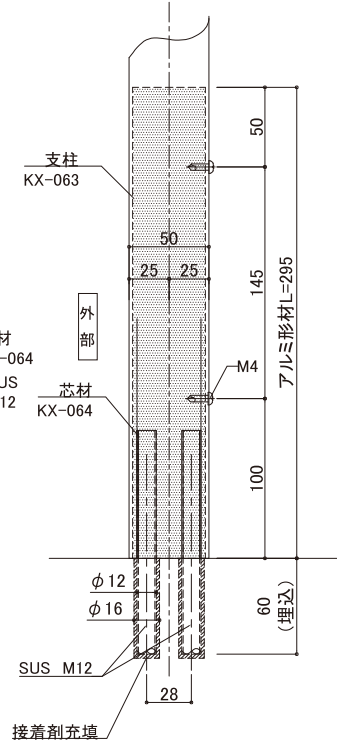
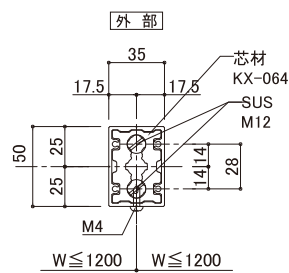
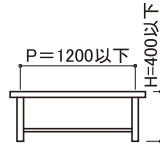

スリムツイン 35	
H=300以下	
水平荷重	3480N
	1,450N/m
躯体巾	120mm

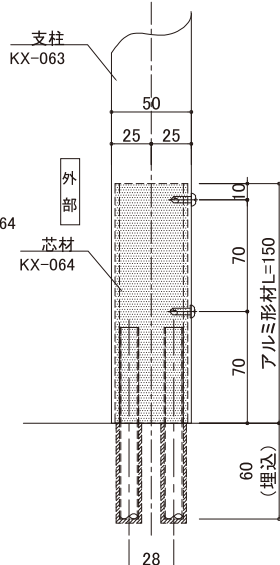
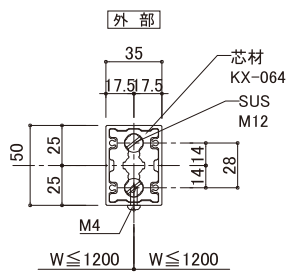
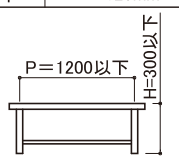

打込みアンカー 35	
トップレール H=300以下	
水平荷重	980N/本
躯体巾	120mm

